

CLG-L236-600

AC lamps

> CONTACT US



CLG-L series LED lights are available with ON/OFF switch and different luminous flux. Available in AC version with the power cable included, this lamps offer the advantages of long service life and low consumption by LED technology.

Technical data		
APPROVALS		
Approvals	CE	
ELECTRICAL DATA		
Rated Voltage	230	V a.c.
Rated Power	6	W
Operating Voltage	207-253	V a.c.
Frequency	50/60	Hz
Appliance Class	II	
GENERIC DATA		
Casing Material	PC	
Electrical Connection	Connector	
Life Expectancy	20000	h at 25 °C
	20000	h at 77 °F
Cable Length	1800	mm
	70.87	in
Fixing System	Screws	
Switch	Manual ON/OFF	
PHOTOMETRIC DATA		
Color Temperature	6500	K
Luminous Flux	595	lm
ENVIRONMENTAL AND THERMAL DATA		
IP Protection Degree	IP20	

Image is for illustrative purpose only. All specifications, data and drawing are subject to change without notice. Please refer to our terms of sales including our warranty and limited liabilities clauses.

CLG-L236-600

AC lamps

> CONTACT US

Technical data		
Operating Temperature	-10÷50	°C
	14÷122	°F
Storage Temperature	-20÷60	°C
	-4÷140	°F

Image is for illustrative purpose only. All specifications, data and drawing are subject to change without notice. Please refer to our terms of sales including our warranty and limited liabilities clauses.

CLG-L236-600

AC lamps

> CONTACT US

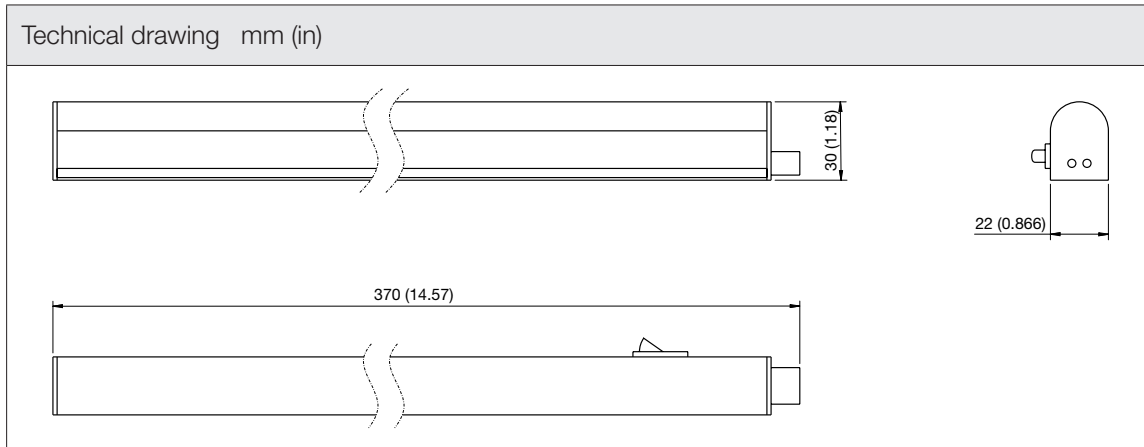

Image is for illustrative purpose only. All specifications, data and drawing are subject to change without notice. Please refer to our terms of sales including our warranty and limited liabilities clauses.